

# 7. Installation

## Securing to the wall



- The weight of the device will be applied to the wall. If the strength of the wall is not sufficient, reinforcement must be done to prevent the transfer of vibration.
- Do not drop or apply unnecessary force to the device when installing. Internal parts may be damaged and may become highly dangerous.
- Install the unit on a vertical wall and ensure that it is level.

Item	Check	Illustration
Locating Screw Holes	<div style="border: 1px solid black; padding: 5px; margin-bottom: 10px;"> <b>Caution</b> <ul style="list-style-type: none"> <li>• When installing with bare hands, take caution to not inflict injury.</li> <li>• Be careful not to hit electrical wiring, gas, or water piping while drilling holes.</li> </ul> </div> <ol style="list-style-type: none"> <li>1. Drill a single screw hole, making sure to hit a stud.</li> <li>2. Insert and tighten the screw and hang the unit by the upper wall mounting bracket.</li> <li>3. Determine the positions for the remaining four screws (two for the top bracket and two for the bottom), and remove the unit.</li> </ol>	<p style="text-align: center;">Location of Screw Hole</p> <p style="text-align: center;">Locating Screw Holes</p>
Mounting	<ol style="list-style-type: none"> <li>4. Drill holes for the remaining four screws.</li> <li>5. Hang the unit again by the first screw, and then insert and tighten the remaining four screws.</li> <li>6. Take waterproofing measures so that water does not enter the building from screws mounting the device.</li> </ol>	<p style="text-align: center;">Tapping Screw</p>
Structure	<ul style="list-style-type: none"> <li>• Make sure the unit is installed securely so that it will not fall or move due to vibrations or earth-quakes.</li> </ul>	

# 8. Vent Pipe Installation (Indoor Installation Only)

## Vent Terminal Installation

- Follow the installation instructions included with the vent terminal and which are reproduced at the end of this manual. This appliance must be vented through the wall, not vertically to the roof.

## Vent Terminal Installation Precautions

Note the following vent terminal installation requirements

- Do not install the vent terminal indoors

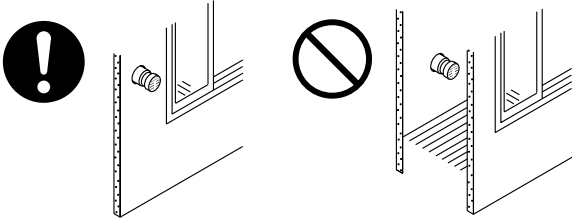

- Install the vent terminal with a downward slope

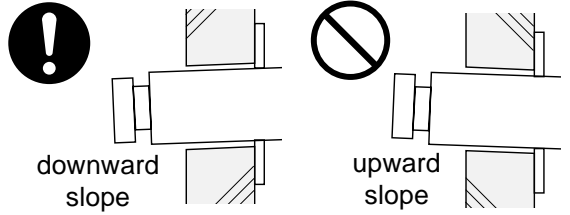

- Install with the proper length protruding through the wall

- Avoid storing hazardous objects near the terminal

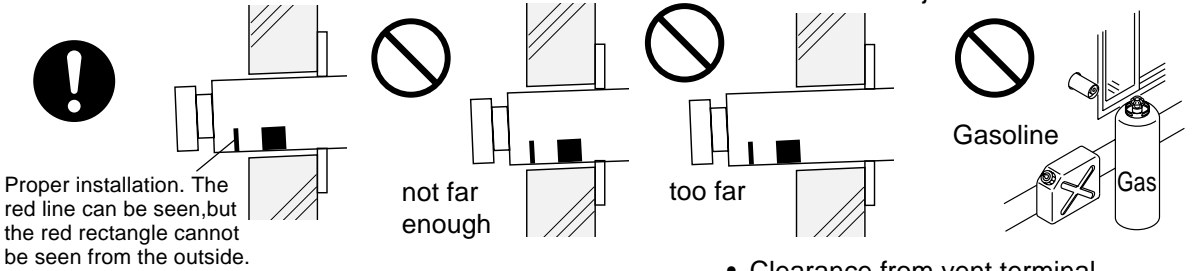

- Avoid installing the terminal where obstacles will block it

- Clearance from vent terminal. If multiple units are installed, terminals must be separated by 12" or more in a plain view regardless of the vertical clearance.

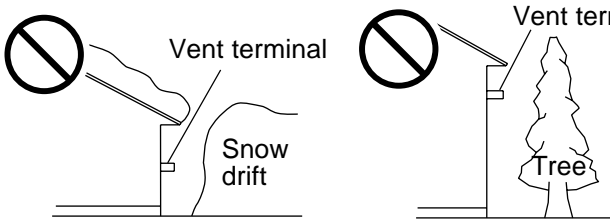

12" or more

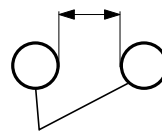

Vent terminal

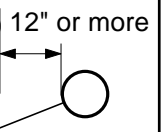

Vent terminal

- Do not install the vent terminals vertically in-line. Do not cover the vent terminal with any type of protective screen or enclosure. In-line or blocked terminals can cause abnormal combustion resulting in undesired performance from the water heater.

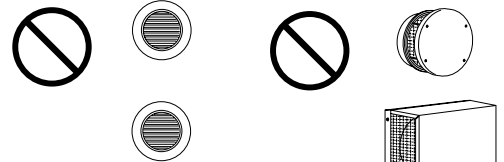

Vertical position not allowed.

## Vent terminal models

- Use only the following models of Noritz vent terminals with this unit.

Vent terminal	• VT4-TL (for long vent runs)
	• VT4-TS (to be installed directly on top of the appliance)

- Vent terminal size variations are listed in the table below. Choose the model according to the wall thickness required.

Model	Wall thickness (in.)
VT4-TL-5	3.5" to 5.1"
VT4-TL-8	5.1" to 8.3"
VT4-TL-14	8.3" to 14.6"
VT4-TL-27	14.6" to 27.2"

## Vent system installation example

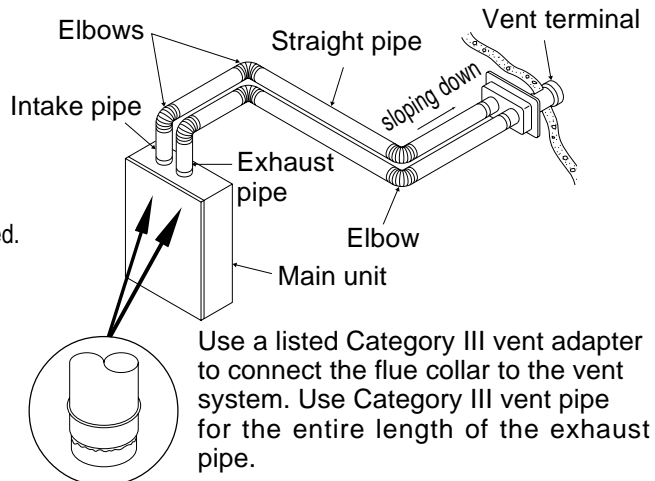

### Venting Precautions

- Use 4" diameter Category III vent pipe.
- Maximum vent length

Number of 90 degree elbows	Maximum Vent Length
4	39'
3	45'
2	51'
1	57'

- Exceeding the maximum vent length is dangerous and may result in bad combustion.
- If possible, don't install the vent pipe through any enclosed areas. If necessary, consult the pipe manufacturer's instructions for clearances.
- Install the vent terminal so that all exhaust is directed to and all intake air is taken from outdoors.

- Do not store hazardous or flammable substances near the vent terminal,
- Slope the intake and exhaust pipes at a 1/50 grade down towards the termination.
- Use only UL listed Category III venting products.
- Connect the vent pipe firmly so that it will prevent exhaust gases from leaking.
- Steam or condensed water may drip out of the vent terminal. Dispose of this condensed water according to local codes and in order to prevent injury or property damage.
- If this product will be installed in an area where snow is known to accumulate, protect the vent termination from blockage by snow drifts or damage from snow falling off of roofs.
- Support the vent pipe with hangers at intervals as required by the vent pipe manufacturer's installation instructions.
- Install the vent terminal so that it is easily accessible for maintenance both from the indoors and the outdoors.
- If the vent terminal will be installed higher than the water heater, make the vertical section directly above the water heater as short as possible, and slope down to the terminal. Do not have another vertical section after the horizontal section begins.
- Make the vertical pipe as short as possible.

- Follow the vent pipe manufacturer's installation instructions.
- Maintain the same vent pipe diameter all the way to the end.
- Maintain the following clearances for the exhaust pipe to combustibles:

Manufacturer and Product	Enclosed		Unenclosed	
	Hor.	Vert.	Hor.	Vert.
Noritz N-Vent	10" (sides) 15" (top) 6" (bottom)	4"	3"	3"
Protech FasNSeal	8" (sides) 12" (top) 4" (bottom)	4"	3"	3"
Protech FasNSeal W2	6"	4"	3"	3"
HeatFab SafTVent	6"	6"	2"	2"
Z-Flex Z-Vent	8"	4"	1"	1"
Flex-L StaR-34	8"	4"	1"	1"

These clearances are subject to change. Refer to the UL listing for the proper clearances.

- Do not common vent or connect more than one appliance to this venting system.

### Appliance Adapters

- Use the following adapters to connect the unit to the venting system.

Manufacturer and Product	Part No.
Protech FasNSeal	FSA44
HeatFab SafTVent	9401RYPK
Z-Flex Z-Vent	2SVWA04
Flex-L StaR-34	SRASPSA4

- Terminate at least 12" above grade or snow line
- Terminate at least 7' above a public walkway
- Use a condensation drain if necessary

## Vertical Vent Termination

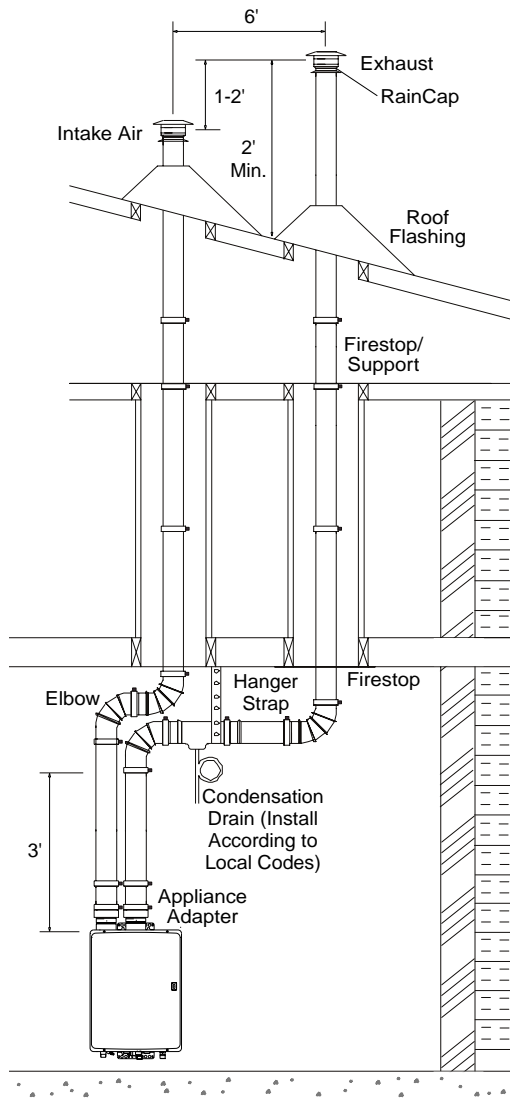

- Terminate at least 6' from the combustion air intake of any appliance, and 3' from any other building opening, gas utility meter, service regulator etc.
- Enclose exterior vent systems below the roof line to limit condensation and protect against mechanical failure.
- When the vent penetrates a floor or ceiling and is not running in a fire rated shaft, a firestop and support is required.
- Terminate the vent system at least 2' above, but not more than 6' above the roof line, or according to the vent pipe manufacturer's instructions.
- Provide vertical support every 12' or as required by the vent pipe manufacturer's instructions.
- Slope the horizontal vent 1/4" downwards for every 12".
- Do not vent straight upwards. Always have a horizontal section of venting.
- Install a condensation drain in the horizontal section of the venting.

When the intake/exhaust pipes pass through an enclosed space:

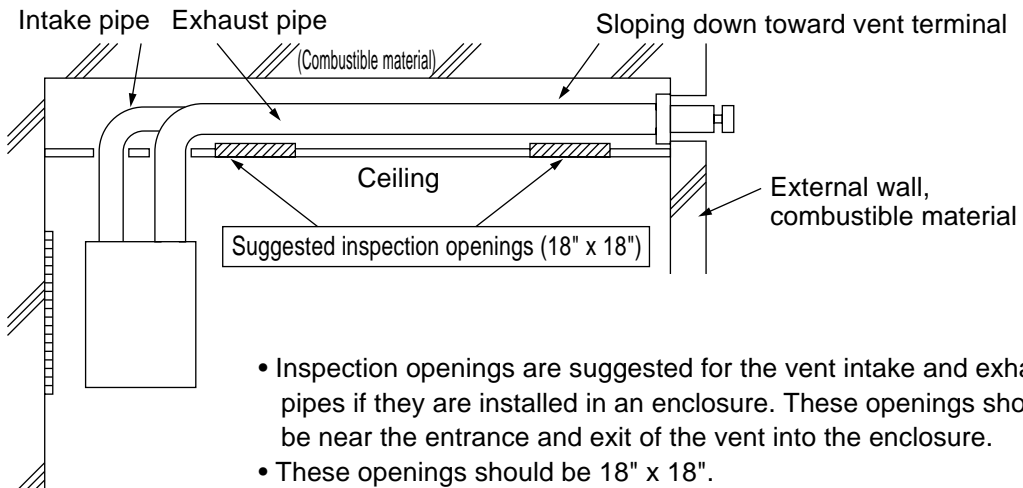

- Inspection openings are suggested for the vent intake and exhaust pipes if they are installed in an enclosure. These openings should be near the entrance and exit of the vent into the enclosure.
- These openings should be 18" x 18".